

# S12NV - 24V AC - Zwei-Wege-Magnetventil mit radialer Demontage

2-Wege-Magnetventil mit NPT-Innengewindeanschlüssen.

Funktion: In Ruhestellung geschlossen. Versorgungsspannung: 24V AC

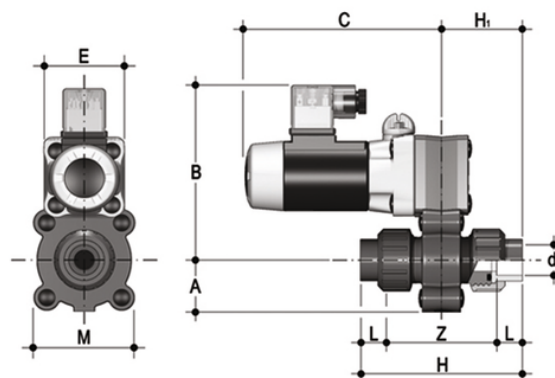

## EPDM

Artikel	A	B	product.detail.attribute.C	Z	E	M	g
S12NV0414E024A	24	100	103	60	42	52	400
S12NV0438E024A	24	100	103	60	42	52	400
S12NV0614E024A	24	100	103	60	42	52	400
S12NV0638E024A	24	100	103	60	42	52	400
S12NV0814E024A	24	100	103	60	42	52	400
S12NV0838E024A	24	100	103	60	42	52	400

## S12NV - 24V AC - Zwei-Wege-Magnetventil mit radialer Demontage

Artikel	A	B	product.detail.attribute.C	Z	E	M	g
S12NV0414F024A	24	100	103	60	42	52	400
S12NV0438F024A	24	100	103	60	42	52	400
S12NV0614F024A	24	100	103	60	42	52	400
S12NV0638F024A	24	100	103	60	42	52	400
S12NV0814F024A	24	100	103	60	42	52	400
S12NV0838F024A	24	100	103	60	42	52	400