

S22IV - 24V AC - Zwei-Wege-Magnetventil mit radialer Demontage

2-Wege-Magnetventil, mit metrischen Innengewindeanschlüssen zum Verkleben.

Funktion: In Ruhestellung geschlossen. Versorgungsspannung: 24V AC

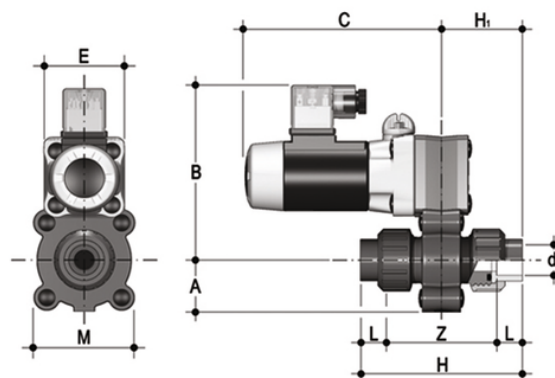

EPDM

Artikel	A	B	product.detail.attribute.C	Z	E	M	g
S22IV0816E024A	34	115	130	71	54	67	1000
S22IV0820E024A	34	115	130	71	54	67	1000
S22IV1016E024A	34	115	130	71	54	67	1000
S22IV1020E024A	34	115	130	71	54	67	1000
S22IV1516E024A	34	115	130	71	54	67	1000
S22IV1520E024A	34	115	130	71	54	67	1000

S22IV - 24V AC - Zwei-Wege-Magnetventil mit radialer Demontage

Artikel	A	B	product.detail.attribute.C	Z	E	M	g
S22IV0816F024A	34	115	130	71	54	67	1000
S22IV0820F024A	34	115	130	71	54	67	1000
S22IV1016F024A	34	115	130	71	54	67	1000
S22IV1020F024A	34	115	130	71	54	67	1000
S22IV1516F024A	34	115	130	71	54	67	1000
S22IV1520F024A	34	115	130	71	54	67	1000