

S22AV - 12V DC - Zwei-Wege-Magnetventil mit radialer Demontage

2-Wege-Magnetventil mit ASTM-Buchsenanschlüssen zum Verkleben.

Funktion: Normalerweise geschlossen. Versorgungsspannung: 12V DC

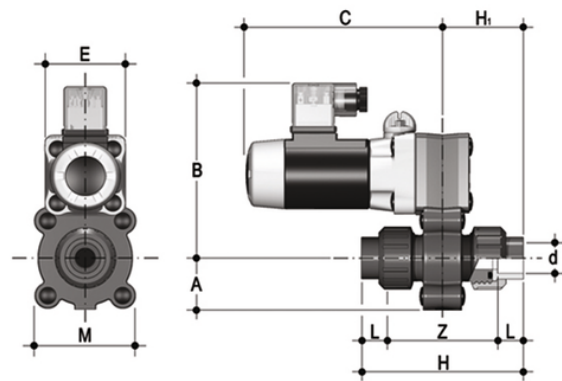

EPDM

Artikel	d	DN	A	B	product.detail.attribute.C	H	product.detail.attribute.H[5:1]	L	Z	E	M	g
S22AV0838E012C	3/8"	8	34	115	130	109	55	19	71	54	67	1000
S22AV0812E012C	1/2"	8	34	115	130	116	58	22	72	54	67	1000
S22AV1038E012C	3/8"	10	34	115	130	109	55	19	71	54	67	1000
S22AV1012E012C	1/2"	10	34	115	130	116	58	22	72	54	67	1000
S22AV1538E012C	3/8"	15	34	115	130	109	55	19	71	54	67	1000
S22AV1512E012C	1/2"	15	34	115	130	116	58	22	72	54	67	1000

S22AV - 12V DC - Zwei-Wege-Magnetventil mit radialer Demontage

Artikel	d	DN	A	B	product.detail.attribute.C	H	product.detail.attribute.H[5:1]	L	Z	E	M	g
S22AV0838F012C	3/8"	8	34	115	130	109	55	19	71	54	67	1000
S22AV0812F012C	1/2"	8	34	115	130	116	58	22	72	54	67	1000
S22AV1038F012C	3/8"	10	34	115	130	109	55	19	71	54	67	1000
S22AV1012F012C	1/2"	10	34	115	130	116	58	22	72	54	67	1000
S22AV1538F012C	3/8"	15	34	115	130	109	55	19	71	54	67	1000
S22AV1512F012C	1/2"	15	34	115	130	116	58	22	72	54	67	1000