

S12FV - 24V AC - true union 2-way solenoid valve

2 way solenoid valve with BSP threaded female union ends.

Function: Normally closed. Power supply: 24V AC

The solenoid valve is the ideal solution for applications requiring many rapid actuation cycles and installations in confined spaces. Thanks to the absence of metal parts in contact with the fluid or the external environment, it can also be used in the presence of aggressive fluids. Ideal for use in fertigation benches.

- Installation flexibility and ease of maintenance: high-performance solenoid electric actuator with internal moving parts designed to exceed 5 million maintenance free operating cycles. Adjustable circular section coil with IP65 protection class.
- DIN 43650 electrical connector supplied as standard: includes LED indicator light and rectifier (in the case of an AC coil).
- Lever shutter in EPDM or FKM and lever in stainless steel.
- Suitable for use with aggressive fluids: no metal component in contact with the fluid or the external environment; all the screws are covered by PE protection plugs.
- Emergency override
- 2-Way PVC-U body
- Installation flexibility and ease of maintenance: high-performance solenoid electric actuator designed to exceed 5 million maintenance-free operating cycles
- Adjustable circular section coil with IP65 protection class.
- Integrated override with the possibility of being installed in 3 different positions.
- Lever shutter in EPDM or FKM and lever in stainless steel.
- DIN 43650 electrical connector supplied as standard: includes LED indicator light and rectifier (in the case of an AC coil).

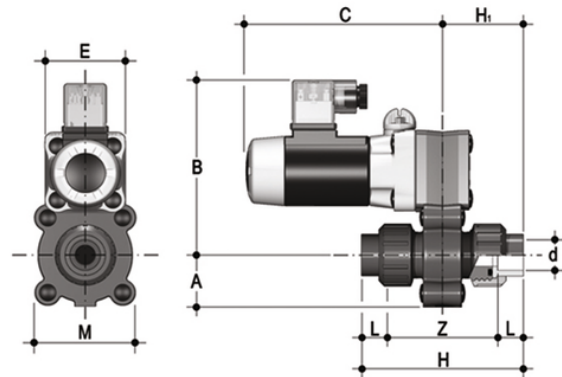
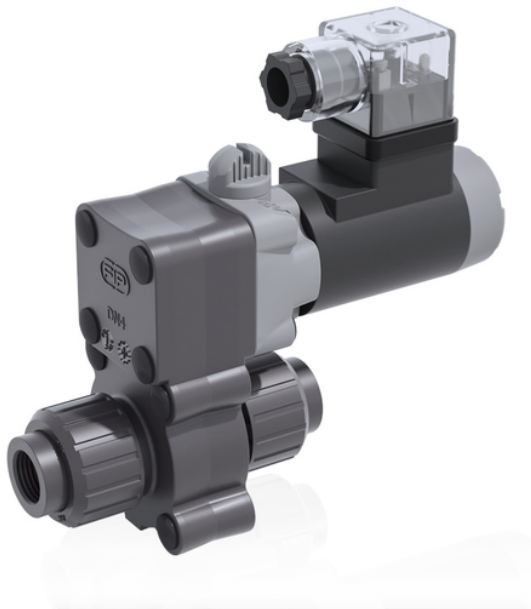

EPDM

Reference	d	DN	A	B	C	H	H1	L	Z	E	M	g
S12FV0414E024A	1/4"	4	24	100	103	85	42	11	63	42	52	400

All information subject to change.

Please contact us on <https://www.aliaxis.co.uk/get-in-touch> for further informations

S12FV - 24V AC - true union 2-way solenoid valve

Reference	d	DN	A	B	C	H	H1	L	Z	E	M	g
S12FV0438E024A	3/8"	4	24	100	103	86	43	11,5	63	42	52	400
S12FV0614E024A	1/4"	6	24	100	103	85	42	11	63	42	52	400
S12FV0638E024A	3/8"	6	24	100	103	86	43	11,5	63	42	52	400
S12FV0814E024A	1/4"	8	24	100	103	85	42	11	63	42	52	400
S12FV0838E024A	3/8"	8	24	100	103	86	43	11,5	63	42	52	400

S12FV - 24V AC - true union 2-way solenoid valve

Reference	d	DN	A	B	C	H	H1	L	Z	E	M	g
S12FV0414F024A	1/4"	4	24	100	103	85	42	11	63	42	52	400
S12FV0438F024A	3/8"	4	24	100	103	86	43	11,5	63	42	52	400
S12FV0614F024A	1/4"	6	24	100	103	85	42	11	63	42	52	400
S12FV0638F024A	3/8"	6	24	100	103	86	43	11,5	63	42	52	400
S12FV0814F024A	1/4"	8	24	100	103	85	42	11	63	42	52	400
S12FV0838F024A	3/8"	8	24	100	103	86	43	11,5	63	42	52	400