

SSEIC/PTFE - Valvola di ritegno bighiera Easyfit a molla DN 10:50

Valvola di ritegno a molla Easyfit con attacchi femmina per incollaggio, serie metrica. Molla in A316 imbustata PTFE.

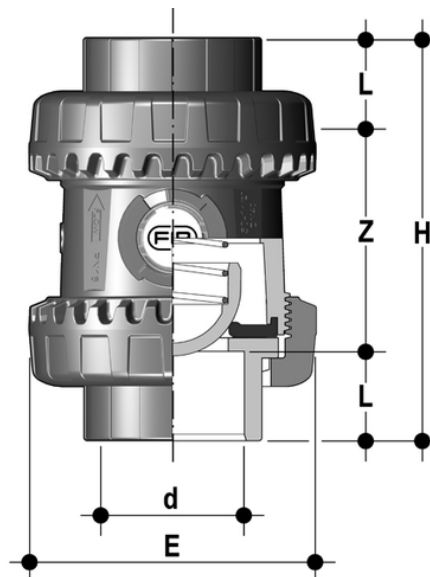

EPDM

Codice	d	DN	PN	E	H	L	Z	g
SSEIC040EOP	40	32	16	85	120	26	68	481
SSEIC050EOP	50	40	16	100	139	31	77	688
SSEIC063EOP	63	50	16	118	174	38	98	1090

FKM

Codice	d	DN	PN	E	H	L	Z	g
SSEIC040FOP	40	32	16	85	120	26	68	481
SSEIC050FOP	50	40	16	100	139	31	77	688
SSEIC063FOP	63	50	16	118	174	38	98	1090