

# S12IV - 230V AC - valvola a solenoide a due vie a smontaggio radiale

Valvola a solenoide a 2 vie, con attacchi metrici a bocchettone femmina per incollaggio.

Funzione: Normalmente Chiusa. Tensione di alimentazione: 230V AC

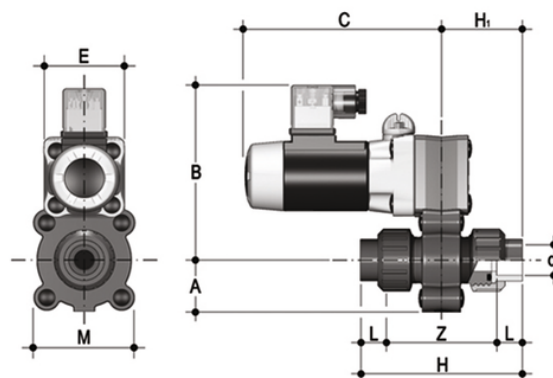
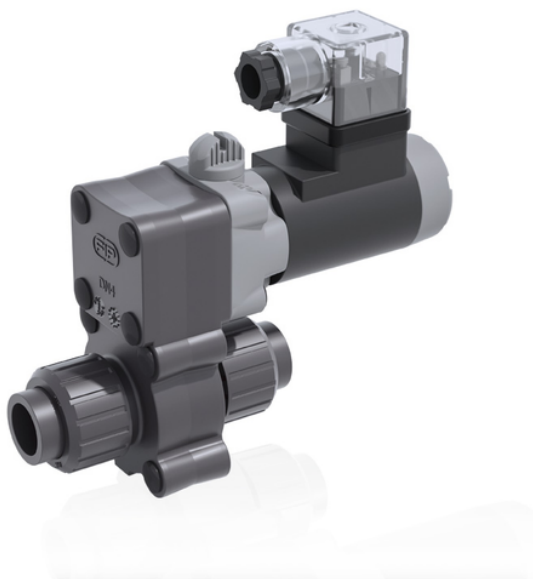

## EPDM

Codice	d	DN	A	B	C	H	H	L	Z	E	M	g
S12IV0410E230A	10	4	24	100	103	84	42	12	60	42	52	400
S12IV0412E230A	12	4	24	100	103	84	42	12	60	42	52	400
S12IV0416E230A	16	4	24	100	103	88	44	14	60	42	52	400
S12IV0610E230A	10	6	24	100	103	84	42	12	60	42	52	400
S12IV0612E230A	12	6	24	100	103	84	42	12	60	42	52	400
S12IV0616E230A	16	6	24	100	103	88	44	14	60	42	52	400
S12IV0810E230A	10	8	24	100	103	88	44	14	60	42	52	400
S12IV0812E230A	12	8	24	100	103	84	42	12	60	42	52	400
S12IV0816E230A	16	8	24	100	103	88	44	14	60	42	52	400

## FKM

Codice	d	DN	A	B	C	H	H	L	Z	E	M	g
S12IV0410F230A	10	4	24	100	103	84	42	12	60	42	52	400
S12IV0412F230A	12	4	24	100	103	84	42	12	60	42	52	400
S12IV0416F230A	16	4	24	100	103	88	44	14	60	42	52	400
S12IV0610F230A	10	6	24	100	103	84	42	12	60	42	52	400

# S12IV - 230V AC - valvola a solenoide a due vie a smontaggio radiale

Codice	d	DN	A	B	C	H	H	L	Z	E	M	g
S12IV0612F230A	12	6	24	100	103	84	44	12	60	42	52	400
S12IV0616F230A	16	6	24	100	103	88	44	14	60	42	52	400
S12IV0810F230A	10	8	24	100	103	84	42	12	60	42	52	400
S12IV0812F230A	12	8	24	100	103	84	42	12	60	42	52	400
S12IV0816F230A	16	8	24	100	103	88	44	14	60	42	52	400