

S12AV - 110V AC - valvola a solenoide a due vie a smontaggio radiale

Valvola a solenoide a 2 vie, con attacchi femmina ASTM a bocchettone per incollaggio.

Funzione: Normalmente Chiusa. Tensione di alimentazione: 110V AC

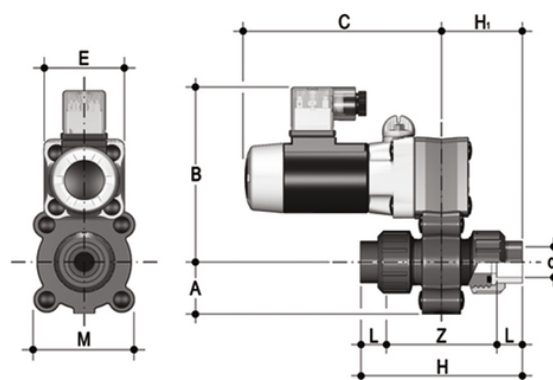

EPDM

Codice	d	DN	A	B	C	H	H ₁	L	Z	E	M	g
S12AV0414E110A	1/4"	4	24	100	103	92	46	16	60	42	52	400
S12AV0438E110A	3/8"	4	24	100	103	98	49	19	60	42	52	400
S12AV0614E110A	1/4"	6	24	100	103	92	46	16	60	42	52	400
S12AV0638E110A	3/8"	6	24	100	103	98	49	19	60	42	52	400
S12AV0814E110A	1/4"	8	24	100	103	92	46	16	60	42	52	400
S12AV0838E110A	3/8"	8	24	100	103	98	49	19	60	42	52	400

FKM

Codice	d	DN	A	B	C	H	H ₁	L	Z	E	M	g
S12AV0414F110A	1/4"	4	24	100	103	92	46	16	60	42	52	400
S12AV0438F110A	3/8"	4	24	100	103	98	49	19	60	42	52	400
S12AV0614F110A	1/4"	6	24	100	103	92	46	16	60	42	52	400
S12AV0638F110A	3/8"	6	24	100	103	98	49	19	60	42	52	400
S12AV0814F110A	1/4"	8	24	100	103	92	46	16	60	42	52	400
S12AV0838F110A	3/8"	8	24	100	103	98	49	19	60	42	52	400