

# S12NV - 24V DC - valvola a solenoide a due vie a smontaggio radiale

Valvola a solenoide a 2 vie, con attacchi femmina filettati NPT a bocchettone.

Funzione: Normalmente Chiusa. Tensione di alimentazione: 24V DC

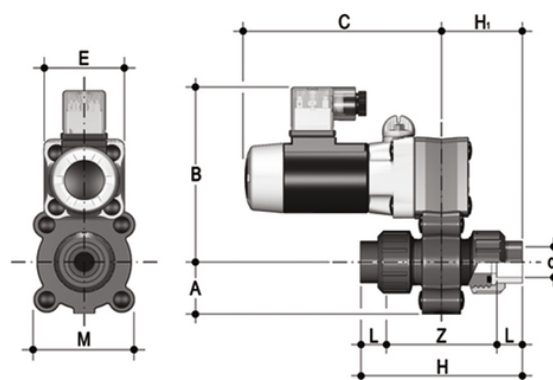

## EPDM

Codice	d	DN	A	B	C	H	H	L	Z	E	M	g
S12NV0414E024C	1/4"	4	24	100	103	91	45	15	61	42	52	400
S12NV0438E024C	3/8"	4	24	100	103	92	46	16	60	42	52	400
S12NV0614E024C	1/4"	6	24	100	103	91	45	15	61	42	52	400
S12NV0638E024C	3/8"	6	24	100	103	92	46	16	60	42	52	400
S12NV0814E024C	1/4"	8	24	100	103	91	45	15	61	42	52	400
S12NV0838E024C	3/8"	8	24	100	103	92	46	16	60	42	52	400

## FKM

Codice	d	DN	A	B	C	H	H	L	Z	E	M	g
S12NV0414F024C	1/4"	4	24	100	103	91	45	15	61	42	52	400
S12NV0438F024C	3/8"	4	24	100	103	92	46	16	60	42	52	400
S12NV0614F024C	1/4"	6	24	100	103	91	45	15	61	42	52	400
S12NV0638F024C	3/8"	6	24	100	103	92	46	16	60	42	52	400
S12NV0814F024C	1/4"	8	24	100	103	91	45	15	61	42	52	400
S12NV0838F024C	3/8"	8	24	100	103	92	46	16	60	42	52	400