

S12FV - 24V DC - valvola a solenoide a due vie a smontaggio radiale

Valvola a solenoide a 2 vie, con attacchi femmina filettati BSP a bocchettone.

Funzione: Normalmente Chiusa. Tensione di alimentazione: 24V DC

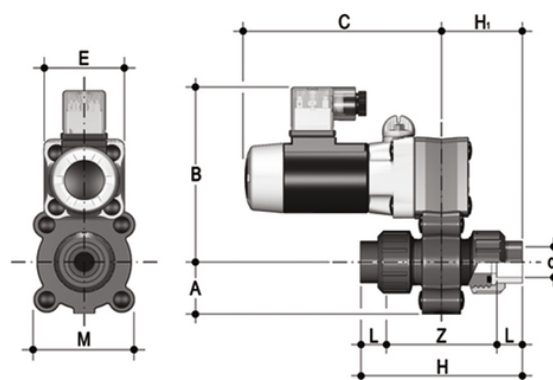

EPDM

Codice	d	DN	A	B	C	H	H	L	Z	E	M	g
S12FV0414E024C	1/4"	4	24	100	103	85	42	11	63	42	52	400
S12FV0438E024C	3/8"	4	24	100	103	86	43	11,5	63	42	52	400
S12FV0614E024C	1/4"	6	24	100	103	85	42	11	63	42	52	400
S12FV0638E024C	3/8"	6	24	100	103	86	43	11,5	63	42	52	400
S12FV0814E024C	1/4"	8	24	100	103	85	42	11	63	42	52	400
S12FV0838E024C	3/8"	8	24	100	103	86	43	11,5	63	42	52	400

FKM

Codice	d	DN	A	B	C	H	H	L	Z	E	M	g
S12FV0414F024C	1/4"	4	24	100	103	85	42	11	63	42	52	400
S12FV0438F024C	3/8"	4	24	100	103	86	43	11,5	63	42	52	400
S12FV0614F024C	1/4"	6	24	100	103	85	42	11	63	42	52	400
S12FV0638F024C	3/8"	6	24	100	103	86	43	11,5	63	42	52	400
S12FV0814F024C	1/4"	8	24	100	103	85	42	11	63	42	52	400
S12FV0838F024C	3/8"	8	24	100	103	86	43	11,5	63	42	52	400