

# S12FV - 24V AC - valvola a solenoide a due vie a smontaggio radiale

Valvola a solenoide a 2 vie, con attacchi femmina filettati BSP a bocchettone.

Funzione: Normalmente Chiusa. Tensione di alimentazione: 24V AC

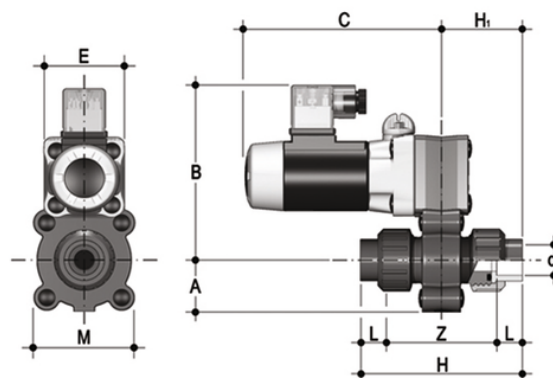

## EPDM

Codice	d	DN	A	B	C	H	H	L	Z	E	M	g
S12FV0414E024A	1/4"	4	24	100	103	85	42	11	63	42	52	400
S12FV0438E024A	3/8"	4	24	100	103	86	43	11,5	63	42	52	400
S12FV0614E024A	1/4"	6	24	100	103	85	42	11	63	42	52	400
S12FV0638E024A	3/8"	6	24	100	103	86	43	11,5	63	42	52	400
S12FV0814E024A	1/4"	8	24	100	103	85	42	11	63	42	52	400
S12FV0838E024A	3/8"	8	24	100	103	86	43	11,5	63	42	52	400

## FKM

Codice	d	DN	A	B	C	H	H	L	Z	E	M	g
S12FV0414F024A	1/4"	4	24	100	103	85	42	11	63	42	52	400
S12FV0438F024A	3/8"	4	24	100	103	86	43	11,5	63	42	52	400
S12FV0614F024A	1/4"	6	24	100	103	85	42	11	63	42	52	400
S12FV0638F024A	3/8"	6	24	100	103	86	43	11,5	63	42	52	400
S12FV0814F024A	1/4"	8	24	100	103	85	42	11	63	42	52	400
S12FV0838F024A	3/8"	8	24	100	103	86	43	11,5	63	42	52	400