

# S22IV - 24V AC - valvola a solenoide a due vie a smontaggio radiale

Valvola a solenoide a 2 vie, con attacchi metrici a bocchettone femmina per incollaggio.

Funzione: Normalmente Chiusa. Tensione di alimentazione: 24V AC

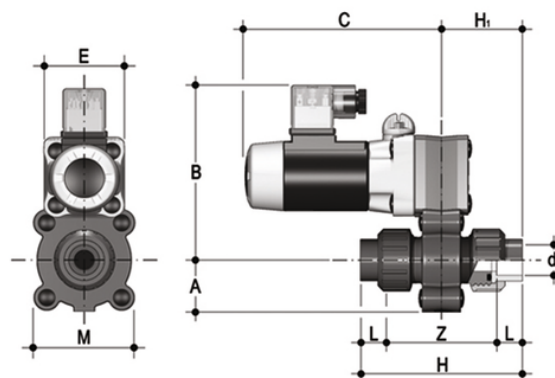

## EPDM

Codice	d	DN	A	B	C	H	H	L	Z	E	M	g
S22IV0816E024A	16	8	34	115	130	99	50	14	71	54	67	1000
S22IV0820E024A	20	8	34	115	130	103	52	16	71	54	67	1000
S22IV1016E024A	16	10	34	115	130	99	50	14	71	54	67	1000
S22IV1020E024A	20	10	34	115	130	103	52	16	71	54	67	1000
S22IV1516E024A	16	15	34	115	130	99	50	14	71	54	67	1000
S22IV1520E024A	20	15	34	115	130	103	52	16	71	54	67	1000

## FKM

Codice	d	DN	A	B	C	H	H	L	Z	E	M	g
S22IV0816F024A	16	8	34	115	130	99	50	14	71	54	67	1000
S22IV0820F024A	20	8	34	115	130	103	52	16	71	54	67	1000
S22IV1016F024A	16	10	34	115	130	99	50	14	71	54	67	1000
S22IV1020F024A	20	10	34	115	130	103	52	16	71	54	67	1000
S22IV1516F024A	16	15	34	115	130	99	50	14	71	54	67	1000
S22IV1520F024A	20	15	34	115	130	103	52	16	71	54	67	1000