

S22FV - 230V AC - valvola a solenoide a due vie a smontaggio radiale

Valvola a solenoide a 2 vie, con attacchi femmina filettati BSP a bocchettone.

Funzione: Normalmente Chiusa. Tensione di alimentazione: 230V AC

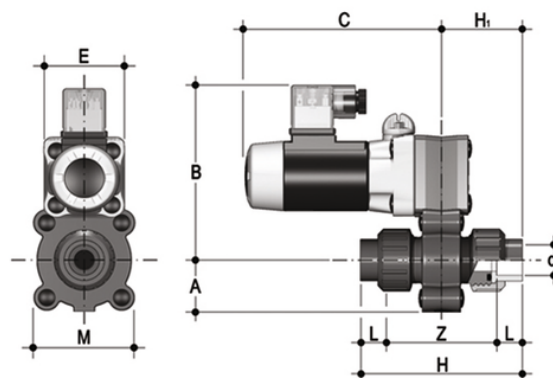

EPDM

Codice	d	DN	A	B	C	H	H	L	Z	E	M	g
S22FV0838E230A	3/8"	8	34	115	130	97	48,5	11,5	74	54	67	1000
S22FV0812E230A	1/2"	8	34	115	130	105	52,5	15	75	54	67	1000
S22FV1038E230A	3/8"	10	34	115	130	97	48,5	11,5	74	54	67	1000
S22FV1012E230A	1/2"	10	34	115	130	105	52,5	15	75	54	67	1000
S22FV1538E230A	3/8"	15	34	115	130	97	48,5	11,5	74	54	67	1000
S22FV1512E230A	1/2"	15	34	115	130	105	52,5	15	75	54	67	1000

FKM

Codice	d	DN	A	B	C	H	H	L	Z	E	M	g
S22FV0838F230A	3/8"	8	34	115	130	97	48,5	11,5	74	54	67	1000
S22FV0812F230A	1/2"	8	34	115	130	105	52,5	15	75	54	67	1000
S22FV1038F230A	3/8"	10	34	115	130	97	48,5	11,5	74	54	67	1000
S22FV1012F230A	1/2"	10	34	115	130	105	52,5	15	75	54	67	1000
S22FV1538F230A	3/8"	15	34	115	130	97	48,5	11,5	74	54	67	1000
S22FV1512F230A	1/2"	15	34	115	130	105	52,5	15	75	54	67	1000