

S22NV - 110V AC -valvola a solenoide a due vie a smontaggio radiale

Valvola a solenoide a 2 vie, con attacchi femmina filettati NPT a bocchettone.

Funzione: Normalmente Chiusa. Tensione di alimentazione: 110V AC

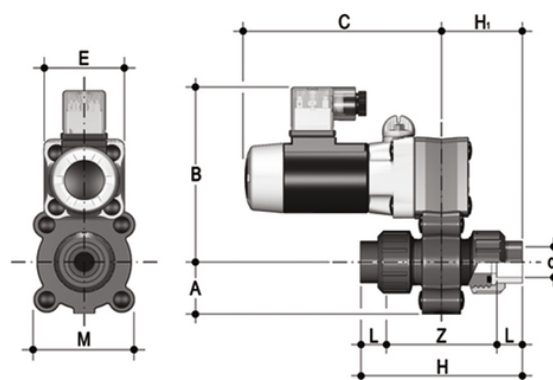
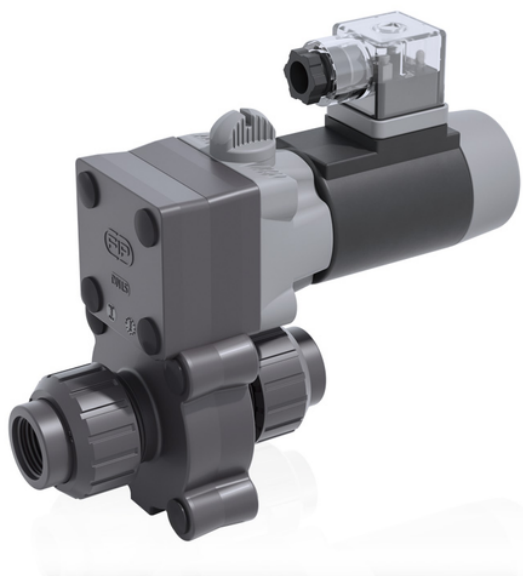

EPDM

Codice	d	DN	A	B	C	H	H	L	Z	E	M	g
S22NV0838E110A	3/8"	8	34	115	130	103	51,5	16	71	54	67	1000
S22NV0812E110A	1/2"	8	34	115	130	112	56	20,5	71	54	67	1000
S22NV1038E110A	3/8"	10	34	115	130	103	51,5	16	71	54	67	1000
S22NV1012E110A	1/2"	10	34	115	130	112	56	20,5	71	54	67	1000
S22NV1538E110A	3/8"	15	34	115	130	103	51,5	16	71	54	67	1000
S22NV1512E110A	1/2"	15	34	115	130	112	56	20,5	71	54	67	1000

FKM

Codice	d	DN	A	B	C	H	H	L	Z	E	M	g
S22NV0838F110A	3/8"	8	34	115	130	103	51,5	16	71	54	67	1000
S22NV0812F110A	1/2"	8	34	115	130	112	56	20,5	71	54	67	1000
S22NV1038F110A	3/8"	10	34	115	130	103	51,5	16	71	54	67	1000
S22NV1012F110A	1/2"	10	34	115	130	112	56	20,5	71	54	67	1000
S22NV1538F110A	3/8"	15	34	115	130	103	51,5	16	71	54	67	1000
S22NV1512F110A	1/2"	15	34	115	130	112	56	20,5	71	54	67	1000